

BELEUCHTUNG



SPANNDECKEN.GMBH
Die Obeneinrichter



TRACK SCHIENEN

TRK 01-1\TRK 01-2

EINPHASEN SCHIENE SOFIMARSEL

TRACK EINPHASEN SCHIENE SOFIMARSEL, LÄNGE 2METER
FARBE: WEIß, SCHWARZ. 220V|16F|IP 20
ANSCHLUßMODUL UND ABSCHLUßELEMENT IM SATZ ENTHALTEN

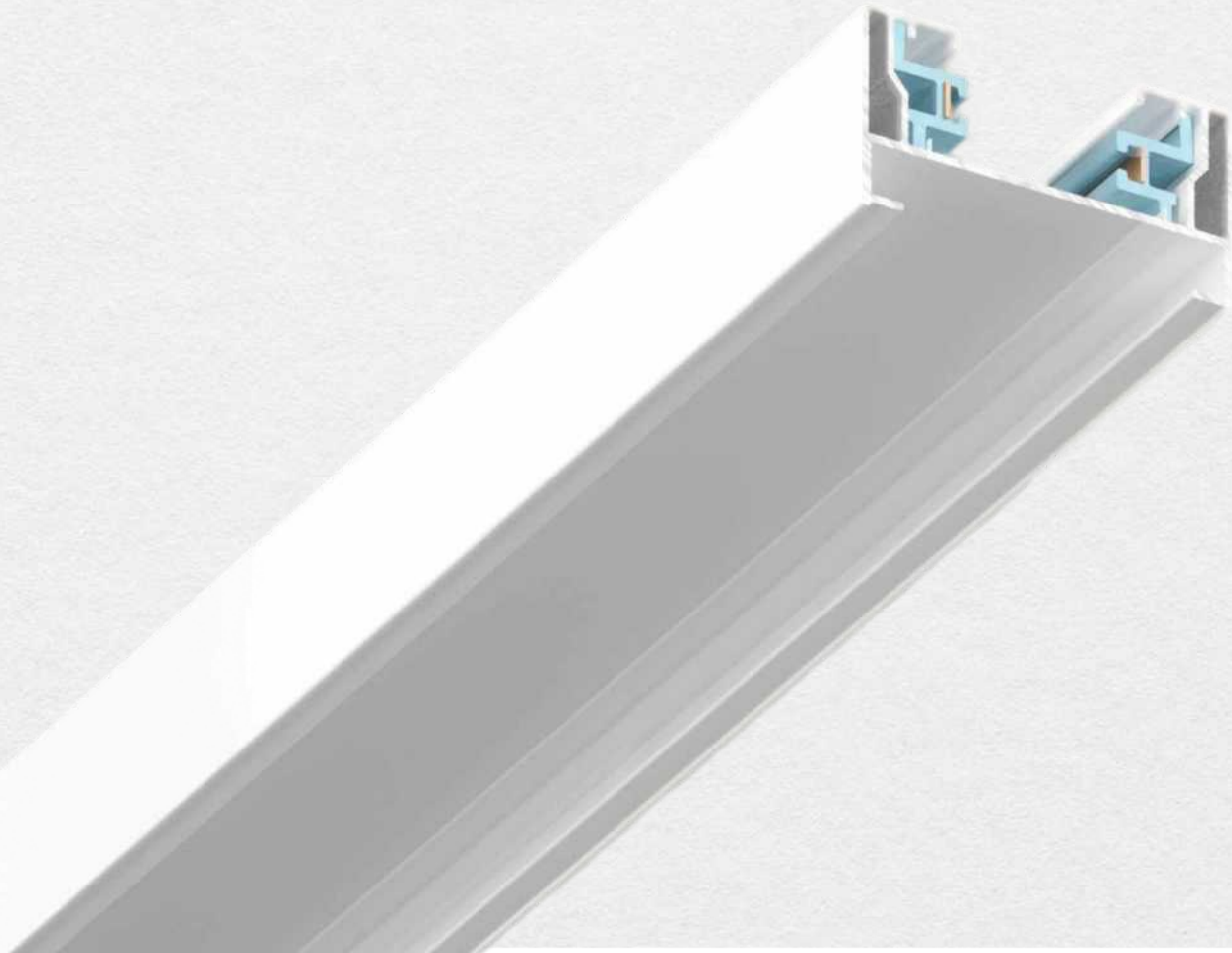



IC01-1\IC01-2

VERBINDER FÜR EINPHASEN TRACK SCHIENE



IC01-3\IC01-4

VERBINDER FÜR EINPHASEN TRACK SCHIENE



IC01-5\IC01-6

VERBINDER FÜR EINPHASEN TRACK SCHIENE



IC01-7\IC01-8

VERBINDER FÜR EINPHASEN TRACK SCHIENE



TRACK LEUCHTEN UND LAMPEN

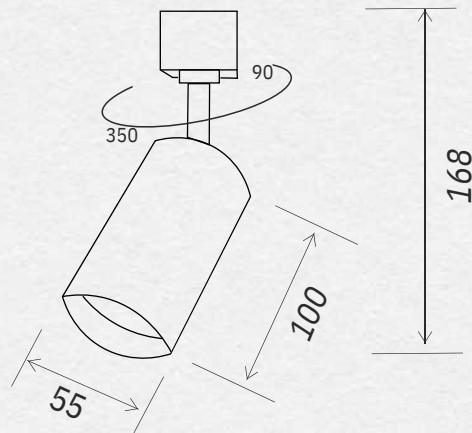

230V/50Hz



Gu10 (MAX 35W)



Ø55x100x168 MM



INTEGRATION MIT PROFIL 07-2

LEUCHTMITTEL IST NICHT ENTHALTEN.

TRL01-1/TRL01-2

TRACK LEUCHTE SOFIMARSEL

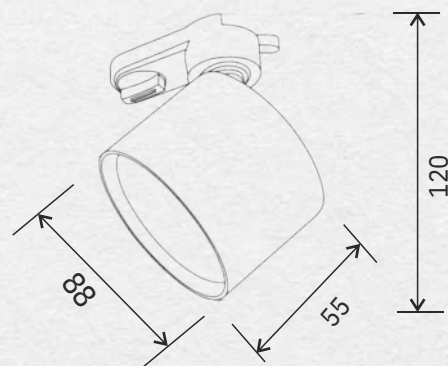

230V/50Hz



GX53 (MAX 35W)



Ø88x55x120MM



INTEGRATION MIT PROFIL 07-2

LEUCHTMITTEL IST NICHT ENTHALTEN.

TRL01-3/TRL01-4

TRACK LEUCHTE SOFIMARSEL



TRL01-5/TRL01-6

TRACK LEUCHE SOFIMARSEL

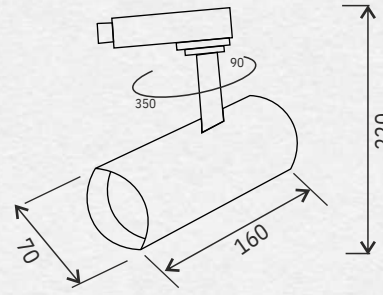

220-240V



LED 12W 4000K



Ø70x160x220MM



INTEGRATION MIT PROFIL 07-2



TRL01-7/TRL01-8

TRACK LEUCHE SOFIMARSEL

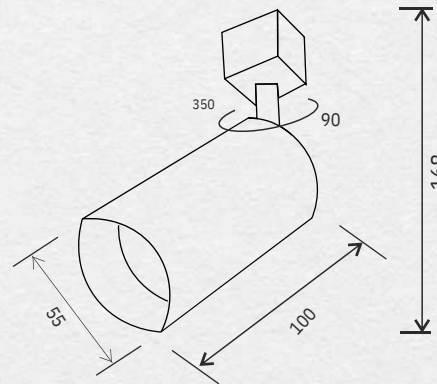

230V/50Hz



GU10 (MAX 35W)



Ø55X100X168MM



INTEGRATION MIT PROFIL 07-2

LEUCHTMITTEL IST NICHT ENTHALTEN.



SPOT LEUCHTEN



SPT 01-1\SPT 01-2

SPOT LEUCHE SOFIMARSEL

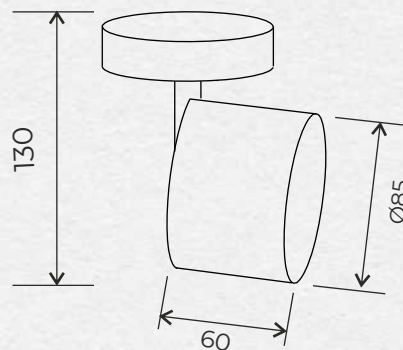

230V/50Hz



GX53 (MAX 35W)



Ø85X60X130MM



KEINE INTEGRATION INS PROFIL 07-2

LEUCHTMITTEL IST NICHT ENHALTEN.

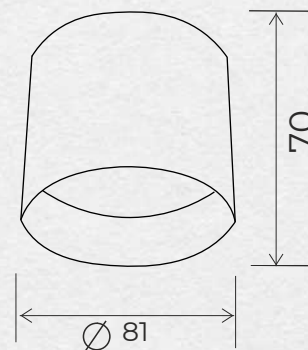

230V/50Hz



GX53 (MAX 35W)



Ø81X70MM



KEINE INTEGRATION INS PROFIL 07-2

LEUCHTMITTEL IST NICHT ENHALTEN.

SPT 01-3\SPT 01-4

SPOT LEUCHE SOFIMARSEL



SPT 01-5\SPT 01-6

SPOT LEUCHE SOFIMARSEL

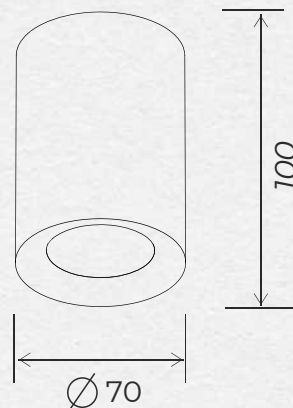

230V/50Hz



GU10 (MAX 35W)



Ø70X100MM



INTEGRATION INS PROFIL 07-2

LEUCHTMITTEL IST NICHT ENHALTEN.



SPT 01-7\SPT 01-8

SPOT LEUCHE SOFIMARSEL

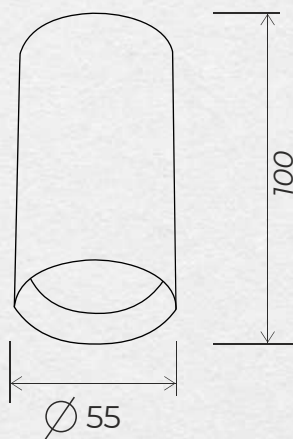

230V/50Hz



GU10 (MAX 35W)



Ø55X100MM



INTEGRATION MIT PROFIL 07-2

LEUCHTMITTEL IST NICHT ENHALTEN.

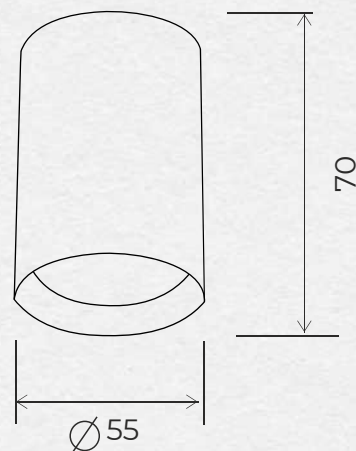

230V/50Hz



GU10 (MAX 35W)



Ø55X70MM



INTEGRATION MIT PROFIL 07-2

LEUCHTMITTEL IST NICHT ENTHALTEN.

SPT 01-9\SPT 01-10

SPOT LEUCHE SOFIMARSEL

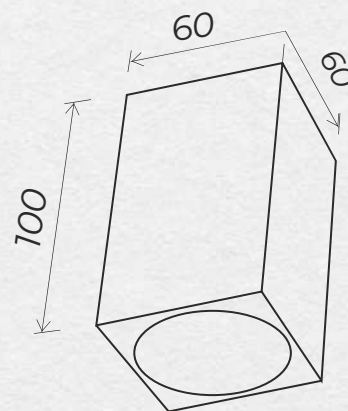

220V



GU10 (MAX 35W)



60X60X100MM



INTEGRATION MIT PROFIL 07-2

LEUCHTMITTEL IST NICHT ENTHALTEN.

SPT 01-11\SPT 01-12

SPOT LEUCHE SOFIMARSEL

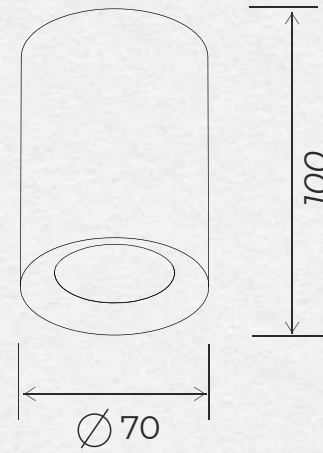

230V/50Hz



GU10 (MAX 35W)



Ø70X100MM



INTEGRATION MIT PROFIL 07-2

LEUCHTMITTEL IST NICHT ENTHALTEN.

SPT 01-13\SPT 01-14

SPOT LEUCHTE SOFIMARSEL

EINBAUSTRAHLER UND LICHTQUELLEN



L01-1
EINBAUSTRAHLER SOFIMARSEL

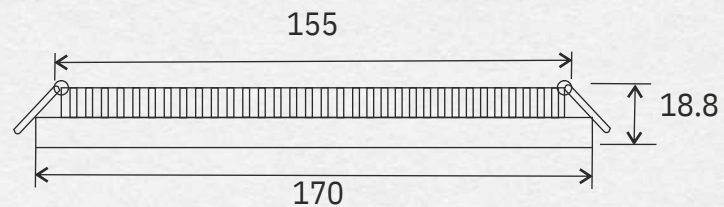

220V 12W/50Hz



GRÖßE: 155 MM

FARBTEMPERATUR: 4000K



L01-2
EINBAUSTRAHLER SOFIMARSEL

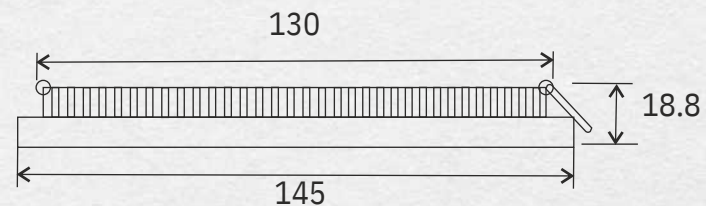

220V 9W/50Hz



GRÖßE: 130 MM

FARBTEMPERATUR: 4000K



L02-1

EINBAUSTRALER SOFIMARSEL

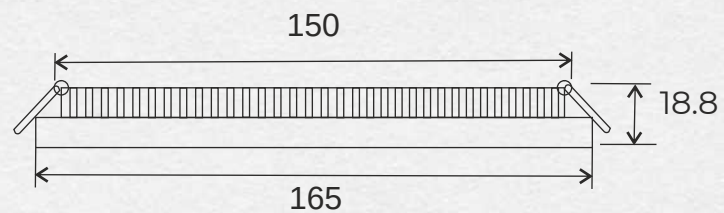

220V 12W/ 50Hz



GRÖßE: 150X150MM

FARBTEMPERATUR: 4000K



L02-2

EINBAUSTRALER SOFIMARSEL

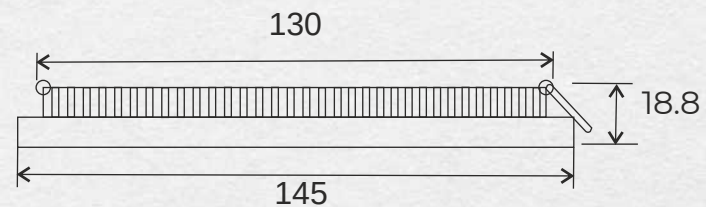

220V 9W/ 50Hz



GRÖßE: 130X130MM

FARBTEMPERATUR: 4000K

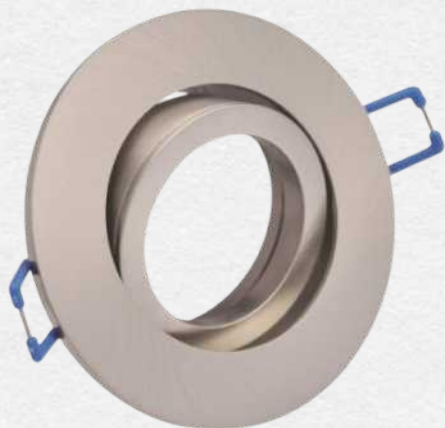

Edelstahlgebürstet - rund

E-1199-1

EINBAUSTRALER

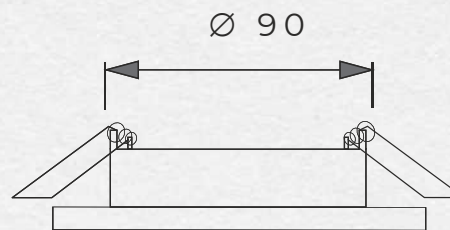

GU 10, LED Modul

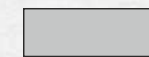

ØINNENDURCHMESSER 68 MM

LEUCHTMITTEL IST NICHT ENTHALTEN.
Passender Verstärkungsring Ø 70

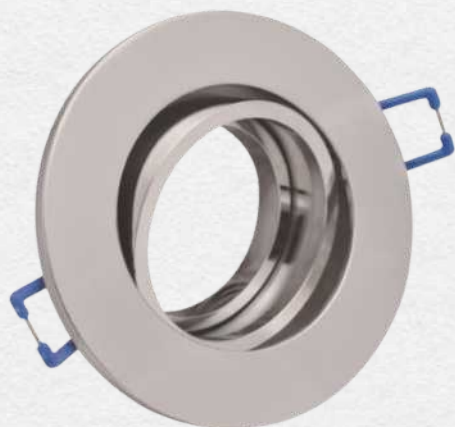

Chrom - rund

E-1199-2

EINBAUSTRALER

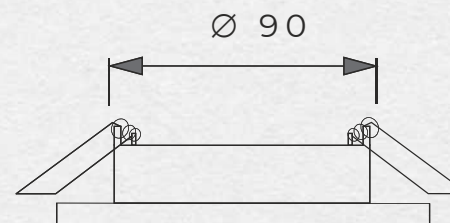

GU 10, LED Modul

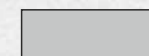

ØINNENDURCHMESSER 68 MM

LEUCHTMITTEL IST NICHT ENTHALTEN.
Passender Verstärkungsring Ø 70

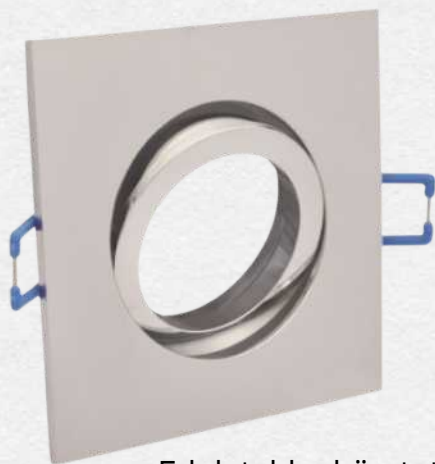

Edelstahlgebürstet - eckig

E-1199-3

EINBAUSTRALER

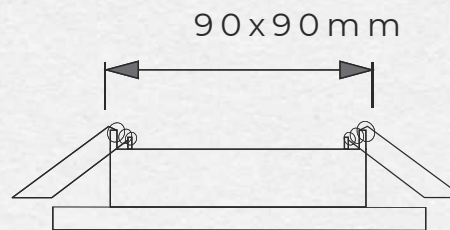

GU 10, LED Modul

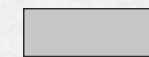

ØINNENDURCHMESSER 68 MM

LEUCHTMITTEL IST NICHT ENTHALTEN.
Passender Verstärkungsring Ø 70



Chrom - eckig

E-1199-4

EINBAUSTRALER

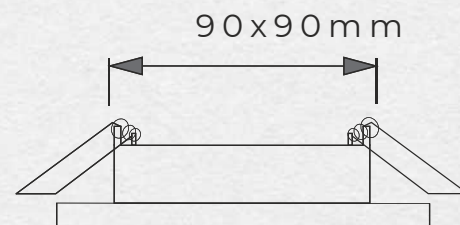

GU 10, LED Modul

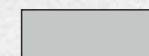

ØINNENDURCHMESSER 68 MM

LEUCHTMITTEL IST NICHT ENTHALTEN.
Passender Verstärkungsring Ø 70

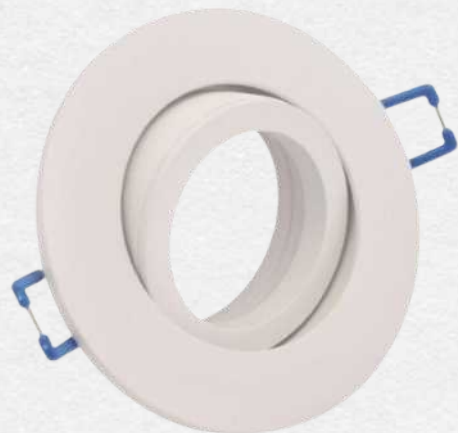

weiß - eckig

E-1199-5

EINBAUSTRALER

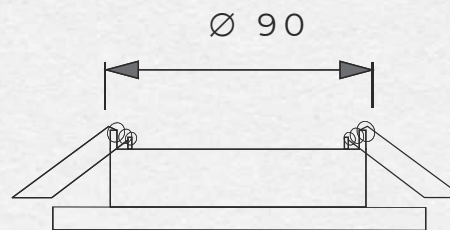

GU 10, LED Modul



ØINNENDURCHMESSER 68 MM

LEUCHTMITTEL IST NICHT ENTHALTEN.
Passender Verstärkungsring Ø 70

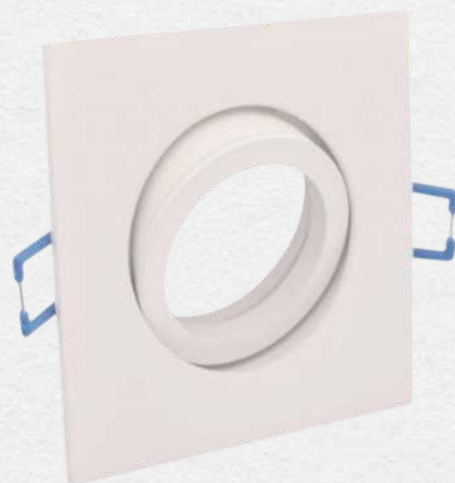

weiß - eckig

E-1199-6

EINBAUSTRALER

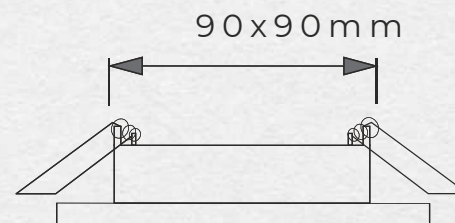

GU 10, LED Modul



ØINNENDURCHMESSER 68 MM

LEUCHTMITTEL IST NICHT ENTHALTEN.
Passender Verstärkungsring Ø 70

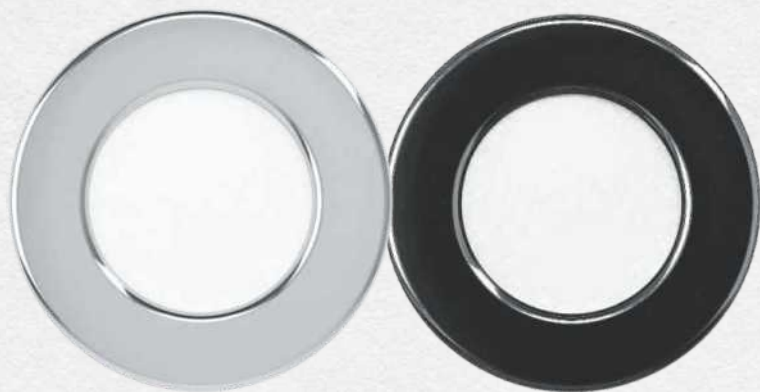

GLAS

SCHWARZ

L08-4/L08-5

EINBAUSTRALER



GLAS

SCHWARZ

L08-6/L08-7

EINBAUSTRALER

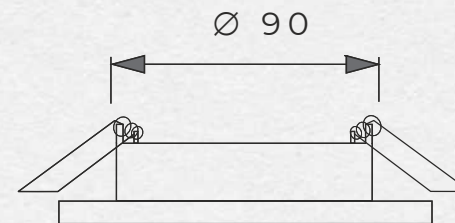

GX53 (MAX 15W) + LED 4W



ØINNENDURCHMESSER 90 MM

LEUCHTMITTEL IST NICHT ENTHALTEN.

LED RANDBELEUCHTUNG LED 4W

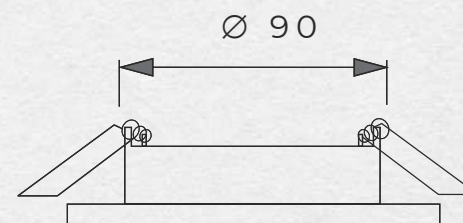

GX53 (MAX 15W) + LED 4W



ØINNENDURCHMESSER 90 MM

LED RANDBELEUCHTUNG LED 4W

LEUCHTMITTEL IST NICHT ENTHALTEN.



GLAS

SCHWARZ

L08-8/L08-9

EINBAUSTRALER



SANDWEISS

L08-10

EINBAUSTRALER

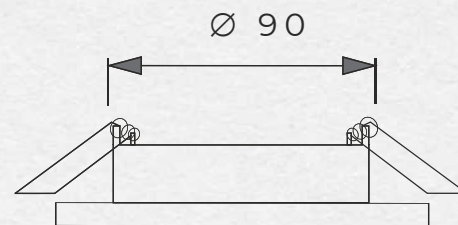

GX53 (MAX 15W) + LED 4W



ØINNENDURCHMESSER 90 MM

LEUCHTMITTEL IST NICHT ENTHALTEN.

LED RANDBELEUCHTUNG LED 4W

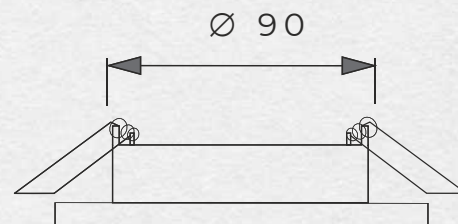

GX53 (MAX 15W) + LED 4W



ØINNENDURCHMESSER 90 MM

LEUCHTMITTEL IST NICHT ENTHALTEN.

LED RANDBELEUCHTUNG LED 4W



SANDWEISS
L08-11
EINBAUSTRALER

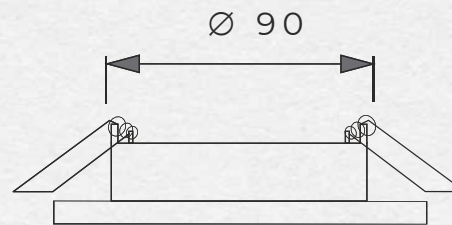

GX53 (MAX 15W) + LED 4W



ØINNENDURCHMESSER 90 MM

LEUCHTMITTEL IST NICHT ENTHALTEN.
LED RANDBELEUCHTUNG LED 4W



SANDWEISS
L08-12
EINBAUSTRALER

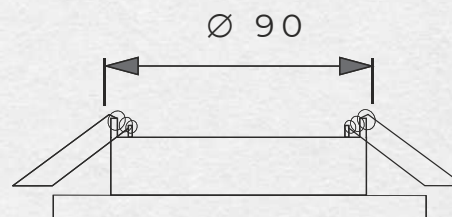

GX53 (MAX 15W) + LED 4W



ØINNENDURCHMESSER 90 MM

LEUCHTMITTEL IST NICHT ENTHALTEN.
LED RANDBELEUCHTUNG LED 4W



SANDWEISS

L08-13

EINBAUSTRALER

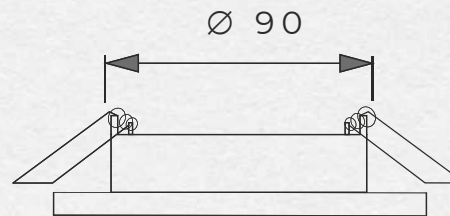

GX53 (MAX 15W) + LED 4W

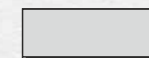

Ø INNENDURCHMESSER 90 MM

LEUCHTMITTEL IST NICHT ENTHALTEN.

LED RANDBELEUCHTUNG LED 4W



SANDWEISS

L08-14

EINBAUSTRALER

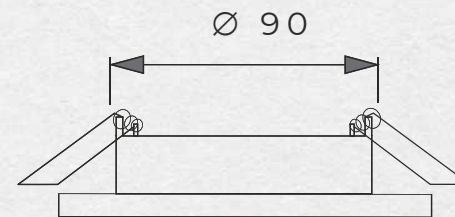

GX53 (MAX 15W) + LED 4W



Ø INNENDURCHMESSER 90 MM

LED RANDBELEUCHTUNG LED 4W

LEUCHTMITTEL IST NICHT ENTHALTEN.



GOLD

L08-15

EINBAUSTRAHLER

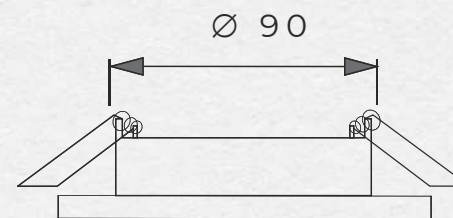

GX53 (MAX 15W)

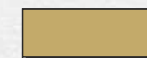

Ø INNENDURCHMESSER 90 MM

LEUCHTMITTEL IST NICHT ENTHALTEN.



STRAHLEND WEISS

L08-16

EINBAUSTRAHLER

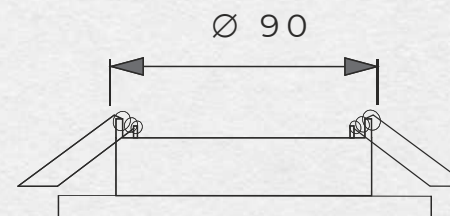

GX53 (MAX 15W)



Ø INNENDURCHMESSER 90 MM

LEUCHTMITTEL IST NICHT ENTHALTEN.



SCHWAR ZCHROM

L08-17

EINBAUSTRALER

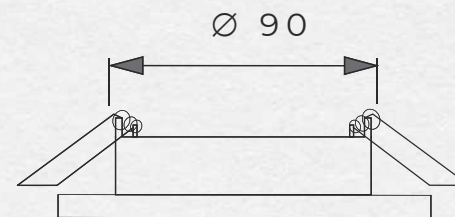

GX53 (MAX 15W)

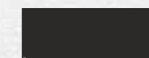

ØINNENDURCHMESSER 90 MM

LEUCHTMITTEL IST NICHT ENTHALTEN.



MATT SCHWARZ

L08-18

EINBAUSTRALER

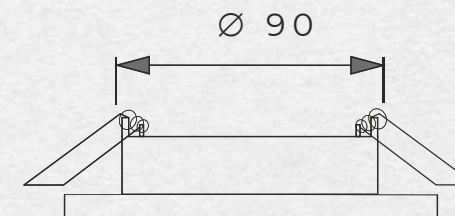

GX53 (MAX 15W)



ØINNENDURCHMESSER 90 MM

LEUCHTMITTEL IST NICHT ENTHALTEN.



AB COLOR

L08-19

EINBAUSTRAHLER

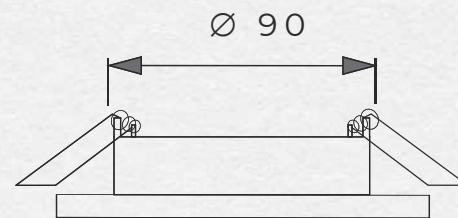

GX53 (MAX 15W)

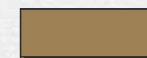

Ø INNENDURCHMESSER 90 MM

LEUCHTMITTEL IST NICHT ENHALTEN.



ROTES KUPFE

L08-20

EINBAUSTRAHLER

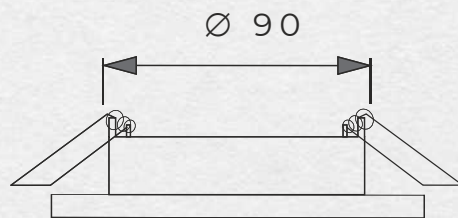

GX53 (MAX 15W)



Ø INNENDURCHMESSER 90 MM

LEUCHTMITTEL IST NICHT ENHALTEN.



B01-10/B01-11 SMD TYPE

LEUCHTMITTEL GU 10



220V 8W



GU10

FARBTEMPERATUR: 4000K

LICHTSTROM: 640 LM



B01-12/B01-15

LEUCHTMITTEL GX 53



220V 11W



GX53

B01-12 FARBTEMPERATUR: 4000K

B01-15 FARBTEMPERATUR: 6000K



B01-13/B01-14

LEUCHTMITTEL GX 53



220V 8W



GX53

B01-13 FARBTEMPERATUR: 4000K

B01-14 FARBTEMPERATUR: 6000K



MAGNETISCHE SCHIENENSYSTEME

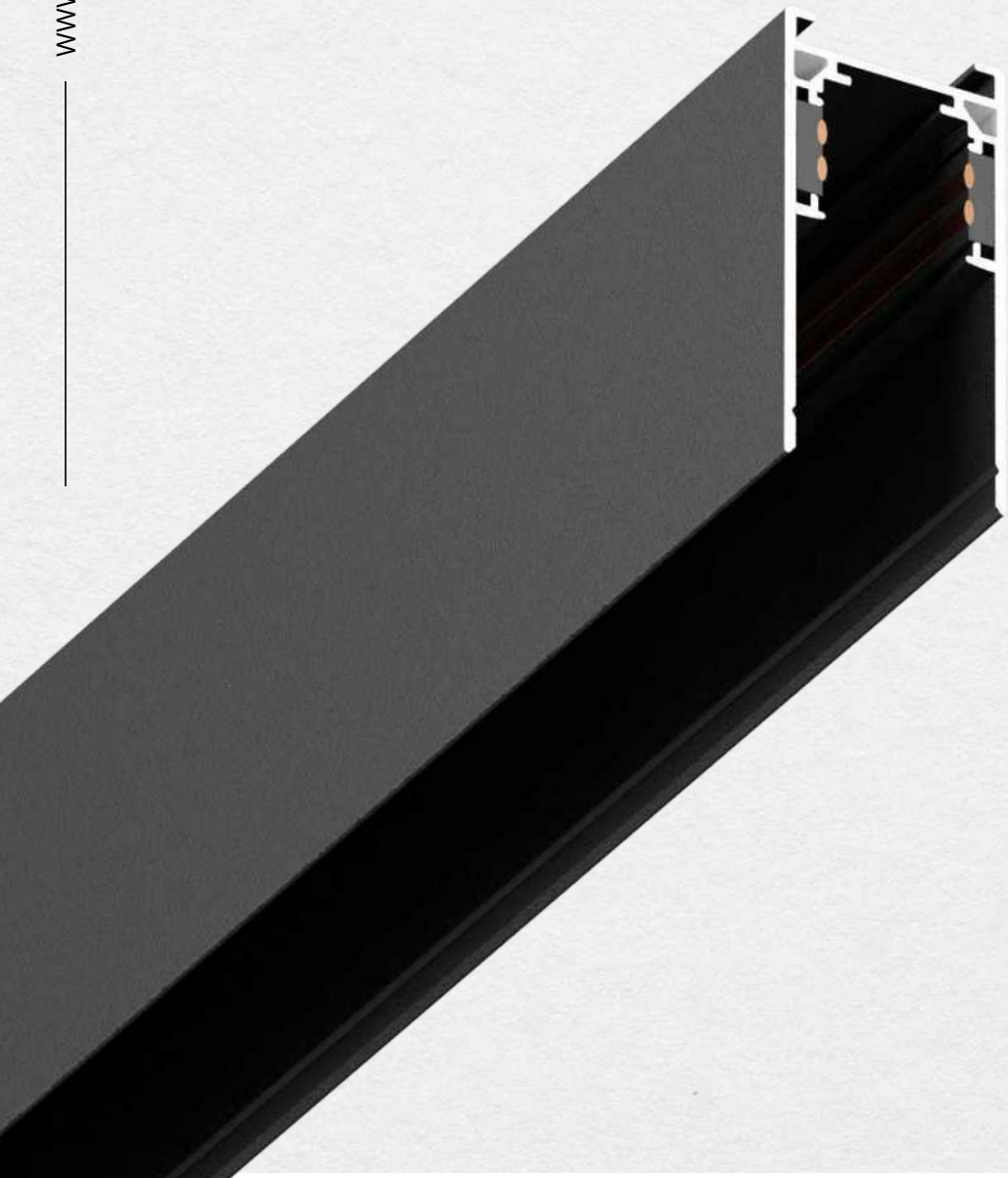

TRM01-1/TRM01-2

MAGNET SCHIENE



48V



TRM01-1
100x26X52MM



TRM01-2
200x26X52MM





IM01-1

ANSCHLUßMODUL DER MAGNET
STROMSCHIENE



IM01-2

GERADE VERBINDER FÜR MAGNET
STROMSCHIENE



IM01-3

WINKEL VERBINDER FÜR MAGNET
STROMSCHIENE



MC01-0

VERBINDER DES PROFILS MAGNETSCHIENE



MC01-1

FERTIGER WINKEL DER MAGNETSTROMSCHIENE
OHNE ANSCHLÜßELEMENTE



ML01-1

MAGNET TRACK LAMPE



48V



LED 12W



220x22x25MM



FARBTEMPERATUR: 4000K



ML01-2

MAGNET TRACK LAMPE



48V



LED 18W



328x22x25MM

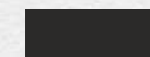

FARBTEMPERATUR: 4000K



ML02-1

MAGNET TRACK LAMPE



48V



LED 10W



340x22x25MM



FARBTEMPERATUR: 4000K

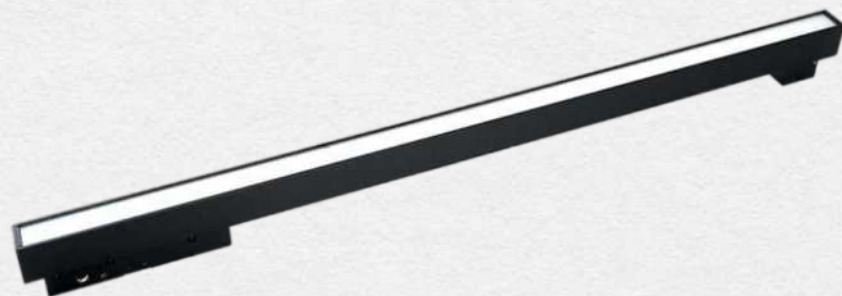

ML02-2

MAGNET TRACK LAMPE



48V



LED 20W



600x22x25MM

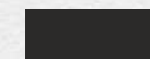

FARBTEMPERATUR: 4000K



ML03-1
MAGNET TRACK LAMPE



48V



LED 12W



220x22x87MM



FARBTEMPERATUR: 4000K



ML04-2

MAGNET TRACK LAMPE



48V



LED 6W



112x22x87MM



FARBTEMPERATUR: 4000K



ML04-3

MAGNET TRACK LAMPE



48V



LED12W



219x22x87MM



FARBTEMPERATUR: 4000K



ML05-1

MAGNET TRACK LAMPE



48V



LED 12W



246x40x22MM



FARBTEMPERATUR: 4000K



ML05-2

MAGNET TRACK LAMPE



48V



LED 18W



360x40x22MM

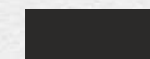

FARBTEMPERATUR: 4000K

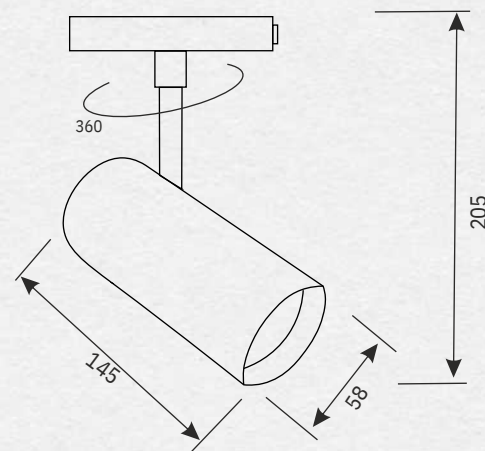

48V



LED 15W



Ø 58X145X205MM



ML06-1
ML06-2

FARBTEMPERATUR: 4000K

ML06-1/ML06-2

MAGNET TRACK LAMPE

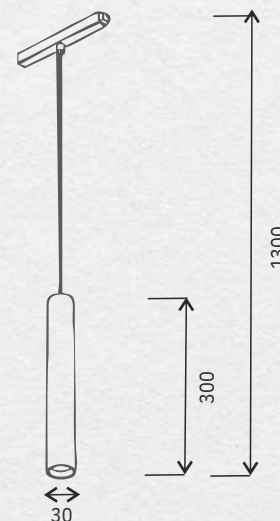

48V



LED 10W



Ø 30x300x1300MM



ML07-1
ML07-2

FARBTEMPERATUR: 4000K

ML07-1/ML07-2

MAGNET TRACK LAMPE



ML08-1/ML08-2

MAGNET TRACK LAMPE

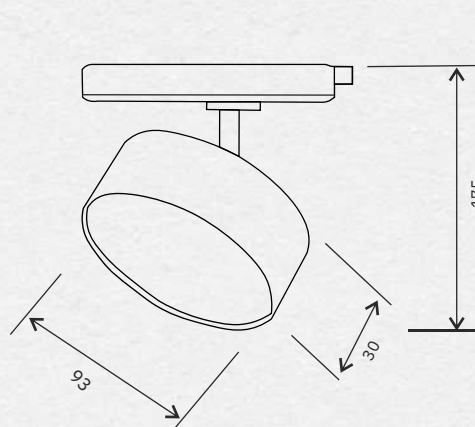

48V



LED 15W



Ø93x30x175 MM



ML08-
ML08-
2

FARBTEMPERATUR: 4000K

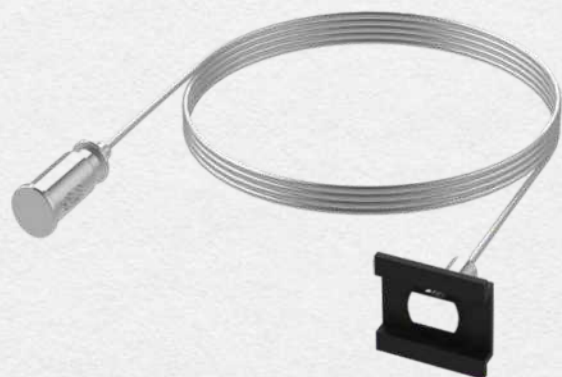

2 M



HM01-1

HÄNGEELEMENT FÜR MAGNET SCHIENE TRM 01-2

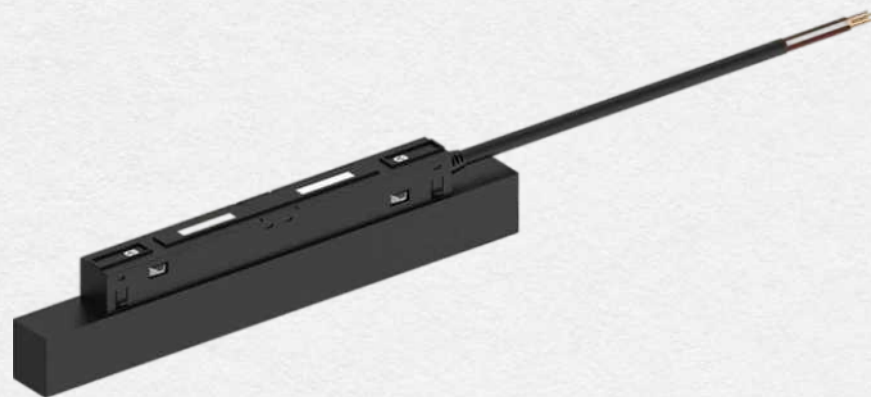

PSM01-1

AUSSEN TRAFO FÜR MAGNET
STROM SCHIENE



100 W / 48 V



220x23x26MM

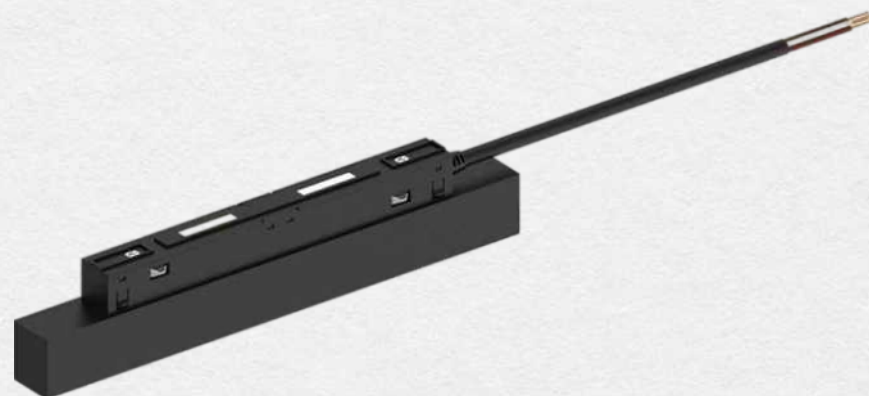
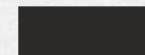

PSM01-2

AUSSEN TRAFO FÜR MAGNET
STROM SCHIENE



200 W / 48 V



310x23x26MM

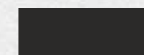



LED BAND 12V

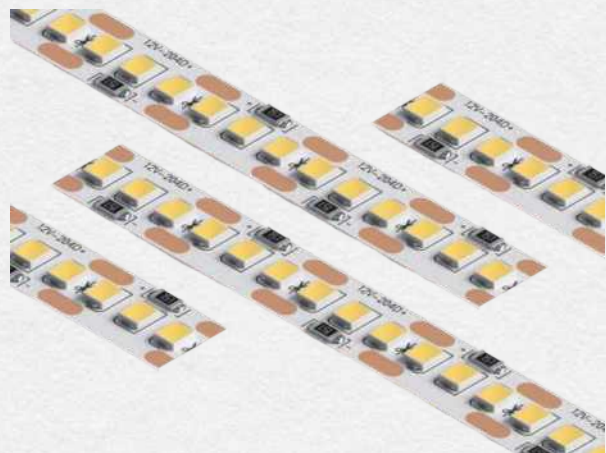

LS01-1/LS01-2/LS01-3
LED BAND 12V





12V 4.8W/R.M



5 METERS

ANZAHL DIODEN: 60 DIODES/METER

LICHTSTROM: 300 LM/R.M

LS01-1	 3000K
LS01-2	 4000K
LS01-3	 6500K

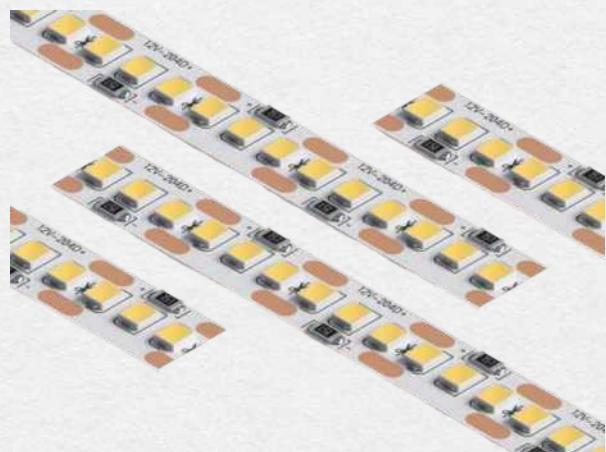

LSS01-1/LSS01-2/LSS01-3
LED BAND 12V





12V 9.6W/R.M



5 METERS
25 METERS

ANZAHL DIODEN: 120 DIODES/METER

LICHTSTROM: 700 LM/R.M

LSS01-1	 3000K
LSS01-2	 4000K
LSS01-3	 6500K

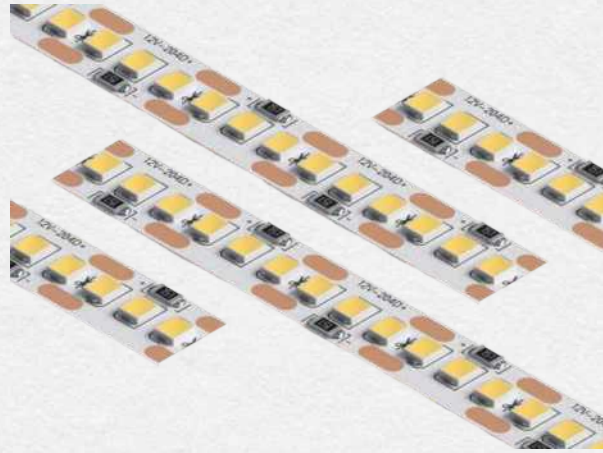

LSS02-1/LSS02-2/LSS02-3

LED BAND 12V



12V 16W/R.M



5 METERS
25 METERS

ANZAHL DIODEN: 204 DIODES/METER

LICHTSTROM: 1400 LM/R.M

LSS02-1	 3000K
LSS02-2	 4000K
LSS02-3	 6500K



LSS03-1 12V

LED BAND RGBW



12V 17W/R.M



25 METERS

ANZAHL DIODEN: 60 DIODES/METER

LED BAND 24V

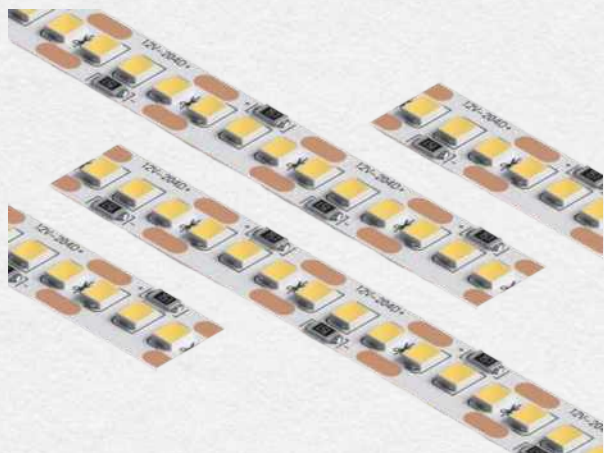

LSS01-1/LSS01-2/LSS01-3

LED BAND 24V



24V 9.6W/R.M



5 METERS
25 METERS

ANZAHL DIODEN: 120 DIODES/METER

LICHTSTROM: 700 LM/R.M

LSS01-1	 3000K
LSS01-2	 4000K
LSS01-3	 6500K

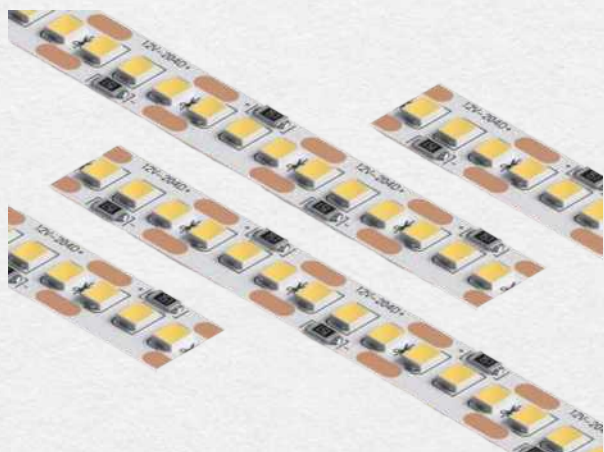

LSS02-1/LSS02-2/LSS02-3

LED BAND 24V



24V 16W/R.M



5 METERS
25 METERS

ANZAHL DIODEN: 204 DIODES/METER

LICHTSTROM: 1400 LM/R.M

LSS02-1	 3000K
LSS02-2	 4000K
LSS02-3	 6500K



LSS03-1 24V

LED BAND RGBW



24V 17W/R.M



5 METERS
25 METERS

ANZAHL DIODEN: 60 DIODES/METER



LED TRAFOS 12V

T01-2	60W	160X40X32MM
T01-3	100W	185X46X36MM
T01-4	150W	200X60X40MM
T01-5	200W	224X69X40MM



LED TRAFOS 24V

KLEINERE ABMESSUNGEN

TS01-1	60W	160X40X32MM
TS01-2	100W	185X47X36MM
TS01-3	150W	200X60X40MM
TS01-4	200W	224X69X40MM

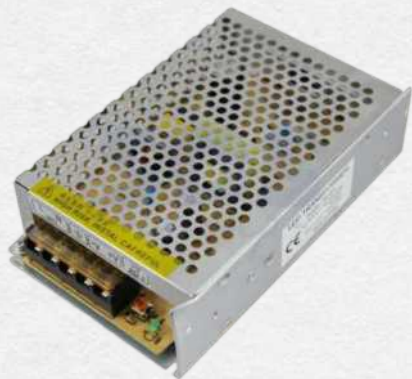

165X53X21MM



48V 100W

TMB01-1 LED TRAFOS 48V 100W



LED TRAFOS 24V SLIM

SM-100W SLIM	100W	168X53X21MM
SM-150W SLIM	150W	235X53X21MM
SM-200W SLIM	200W	235X53X21MM
SM-300W SLIM	300W	308X53X21MM
SM-400W SLIM	400W	308X53X21MM



K01-2

2.4G RGBW CONTROLLER



12-24V 24A

BATTERIEN ENTHALTEN



12V-24V 24A



77X63X23 MM

AM 01-1

RGB VERSTÄRKER

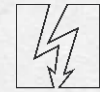

12-24V

F01-3 20A

PULSE-WIDTH MODULATION
12\24V



K02-1



K02-2



K02-3

FUNKSCHALTER 220V



220V



LEISTUNG: 2000W/3000W/4000W

1000 W JEDER KANAL

K01-01 2 KANÄLE

K01-02 3 KANÄLE

K01-03 4 KANÄLE



D01-1
LED DIMMER



DC 12V - 24V

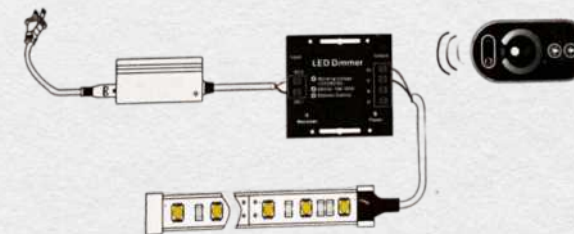

LED BÄNDER 24V